

BSP 373

SIPMOS® Small-Signal Transistor

- N channel
- Enhancement mode
- Avalanche rated
- $V_{GS(th)} = 2.1 \dots 4.0 \text{ V}$
- Pb-free lead plating; RoHS compliant available

drain pins 2, 4



source pin3

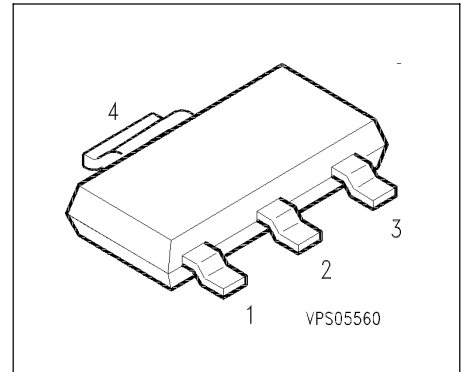

Pin 1	Pin 2	Pin 3	Pin 4
G	D	S	D

Type	V_{DS}	I_D	$R_{DS(on)}$	Package	Marking
BSP 373	100 V	1.7 A	0.3 Ω	PG-SOT-223	BSP 373

Type	RoHS compliant	Tape and Reel Information
BSP 373	Yes	L6327: 1000 pcs/reel

Maximum Ratings

Parameter	Symbol	Values	Unit
Continuous drain current $T_A = 28 \text{ }^\circ\text{C}$	I_D	1.7	A
DC drain current, pulsed $T_A = 25 \text{ }^\circ\text{C}$	I_{Dpuls}	6.8	
Avalanche energy, single pulse $I_D = 1.7 \text{ A}$, $V_{DD} = 25 \text{ V}$, $R_{GS} = 25 \text{ } \Omega$ $L = 23.3 \text{ mH}$, $T_j = 25 \text{ }^\circ\text{C}$	E_{AS}	45	mJ
Gate source voltage	V_{GS}	± 20	V
Power dissipation $T_A = 25 \text{ }^\circ\text{C}$	P_{tot}	1.8	W

Maximum Ratings

Parameter	Symbol	Values	Unit
Chip or operating temperature	T_j	-55 ... + 150	°C
Storage temperature	T_{stg}	-55 ... + 150	
Thermal resistance, chip to ambient air	R_{thJA}	≤ 70	K/W
Thermal resistance, junction-soldering point ¹⁾	R_{thJS}	≤ 10	
DIN humidity category, DIN 40 040		E	
IEC climatic category, DIN IEC 68-1		55 / 150 / 56	

1) Transistor on epoxy pcb 40 mm x 40 mm x 1,5 mm with 6 cm² copper area for drain connection

Electrical Characteristics, at $T_j = 25^\circ\text{C}$, unless otherwise specified

Parameter	Symbol	Values			Unit
		min.	typ.	max.	

Static Characteristics

Drain- source breakdown voltage $V_{GS} = 0\text{ V}, I_D = 0.25\text{ mA}, T_j = 0^\circ\text{C}$	$V_{(BR)DSS}$	100	-	-	V
Gate threshold voltage $V_{GS} = V_{DS}, I_D = 1\text{ mA}$	$V_{GS(th)}$	2.1	3	4	
Zero gate voltage drain current $V_{DS} = 100\text{ V}, V_{GS} = 0\text{ V}, T_j = 25^\circ\text{C}$ $V_{DS} = 100\text{ V}, V_{GS} = 0\text{ V}, T_j = 125^\circ\text{C}$	I_{DSS}	-	0.1 10	1 100	μA
Gate-source leakage current $V_{GS} = 20\text{ V}, V_{DS} = 0\text{ V}$	I_{GSS}	-	10	100	
Drain-Source on-state resistance $V_{GS} = 10\text{ V}, I_D = 1.7\text{ A}$	$R_{DS(on)}$	-	0.16	0.3	Ω

Electrical Characteristics, at $T_j = 25^\circ\text{C}$, unless otherwise specified

Parameter	Symbol	Values			Unit
		min.	typ.	max.	

Dynamic Characteristics

Transconductance $V_{DS} \geq 2 \cdot I_D \cdot R_{DS(on)max}$, $I_D = 1.7\text{ A}$	g_{fs}	1.5	2.8	-	S
Input capacitance $V_{GS} = 0\text{ V}$, $V_{DS} = 25\text{ V}$, $f = 1\text{ MHz}$	C_{iss}	-	400	550	pF
Output capacitance $V_{GS} = 0\text{ V}$, $V_{DS} = 25\text{ V}$, $f = 1\text{ MHz}$	C_{oss}	-	125	190	
Reverse transfer capacitance $V_{GS} = 0\text{ V}$, $V_{DS} = 25\text{ V}$, $f = 1\text{ MHz}$	C_{rss}	-	70	105	
Turn-on delay time $V_{DD} = 30\text{ V}$, $V_{GS} = 10\text{ V}$, $I_D = 0.3\text{ A}$ $R_{GS} = 50\ \Omega$	$t_{d(on)}$	-	10	15	ns
Rise time $V_{DD} = 30\text{ V}$, $V_{GS} = 10\text{ V}$, $I_D = 0.3\text{ A}$ $R_{GS} = 50\ \Omega$	t_r	-	30	45	
Turn-off delay time $V_{DD} = 30\text{ V}$, $V_{GS} = 10\text{ V}$, $I_D = 0.3\text{ A}$ $R_{GS} = 50\ \Omega$	$t_{d(off)}$	-	85	115	
Fall time $V_{DD} = 30\text{ V}$, $V_{GS} = 10\text{ V}$, $I_D = 0.3\text{ A}$ $R_{GS} = 50\ \Omega$	t_f	-	60	80	

Electrical Characteristics, at $T_j = 25^\circ\text{C}$, unless otherwise specified

Parameter	Symbol	Values			Unit
		min.	typ.	max.	
Reverse Diode					
Inverse diode continuous forward current $T_A = 25^\circ\text{C}$	I_S	-	-	1.7	A
Inverse diode direct current, pulsed $T_A = 25^\circ\text{C}$	I_{SM}	-	-	6.8	
Inverse diode forward voltage $V_{GS} = 0\text{ V}$, $I_F = 1.7\text{ A}$, $T_j = 25^\circ\text{C}$	V_{SD}	-	0.8	1.1	V
Reverse recovery time $V_R = 30\text{ V}$, $I_F = I_S$, $di_F/dt = 100\text{ A}/\mu\text{s}$	t_{rr}	-	-	-	ns
Reverse recovery charge $V_R = 30\text{ V}$, $I_F = I_S$, $di_F/dt = 100\text{ A}/\mu\text{s}$	Q_{rr}	-	-	-	μC

Power dissipation

$P_{tot} = f(T_A)$

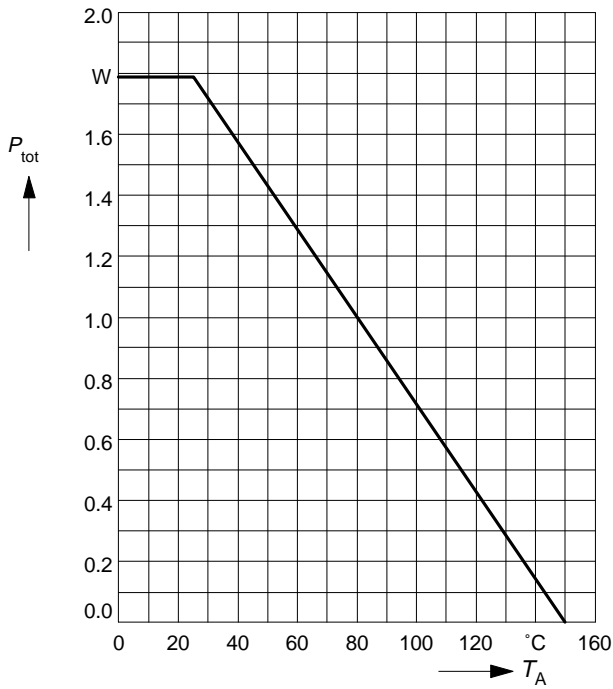

Drain current

$I_D = f(T_A)$

parameter: $V_{GS} \geq 10\text{ V}$

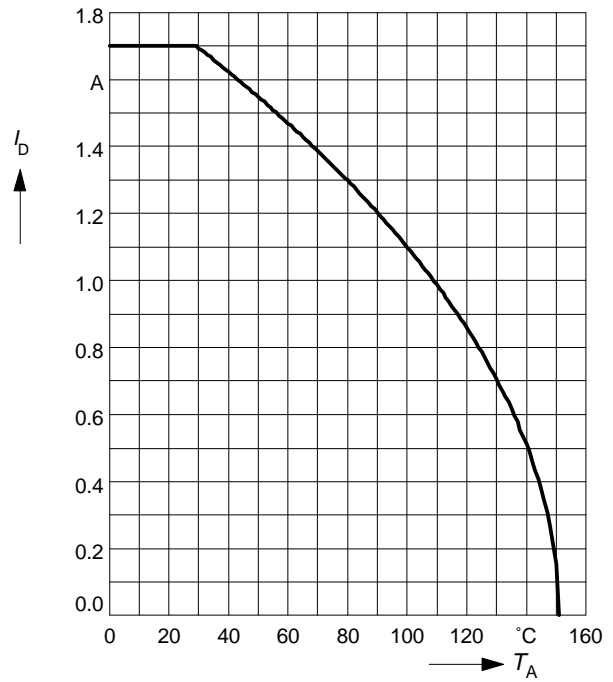

Safe operating area $I_D = f(V_{DS})$

parameter : $D = 0, T_C = 25^\circ\text{C}$

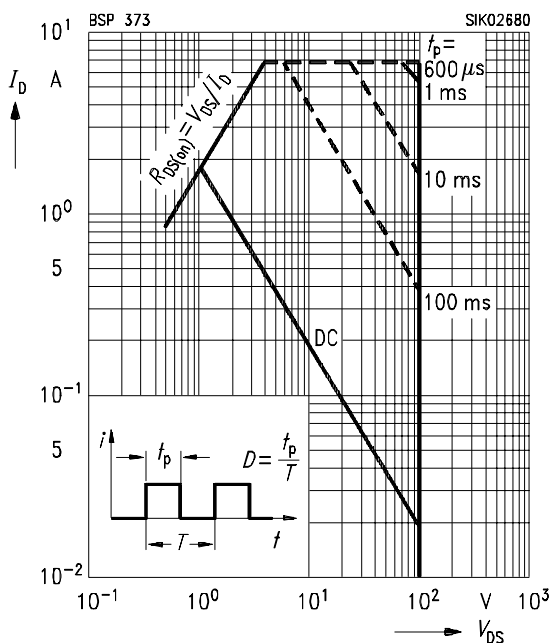

Transient thermal impedance

$Z_{thJA} = f(t_p)$

parameter: $D = t_p / T$

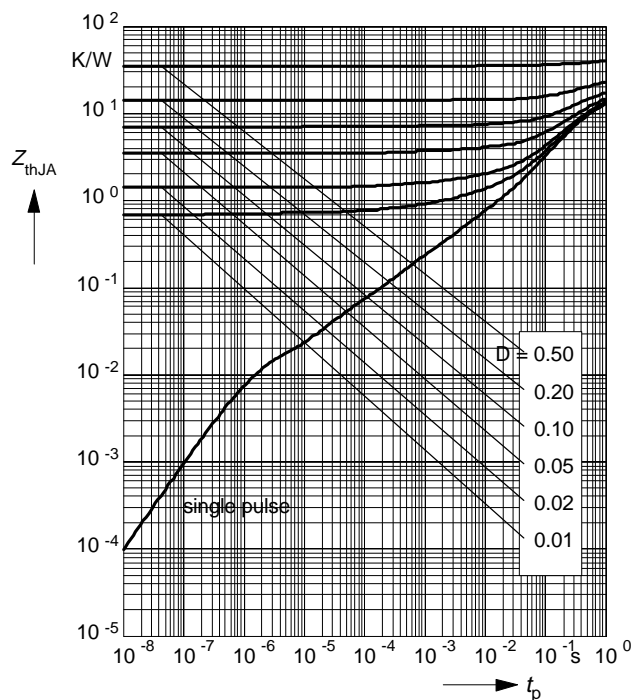

Typ. output characteristics

$I_D = f(V_{DS})$

parameter: $t_p = 80 \mu s$

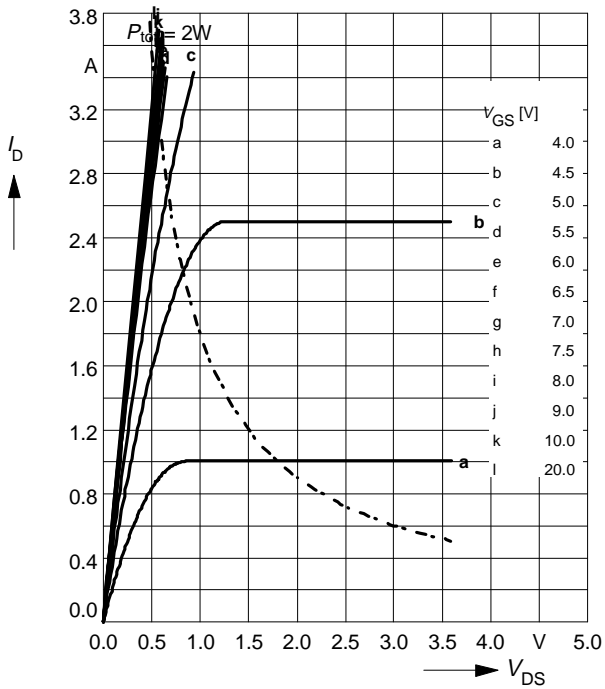

Typ. drain-source on-resistance

$R_{DS(on)} = f(I_D)$

parameter: $t_p = 80 \mu s, T_j = 25^\circ C$

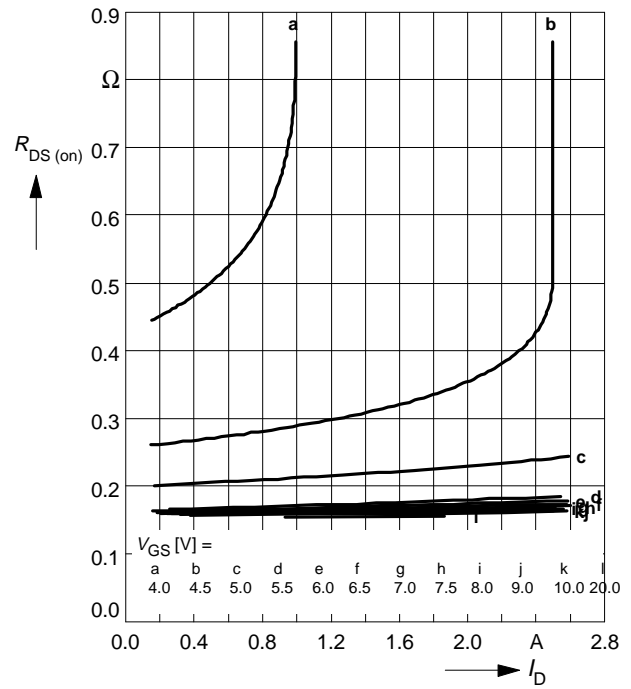

Typ. transfer characteristics $I_D = f(V_{GS})$

parameter: $t_p = 80 \mu s$

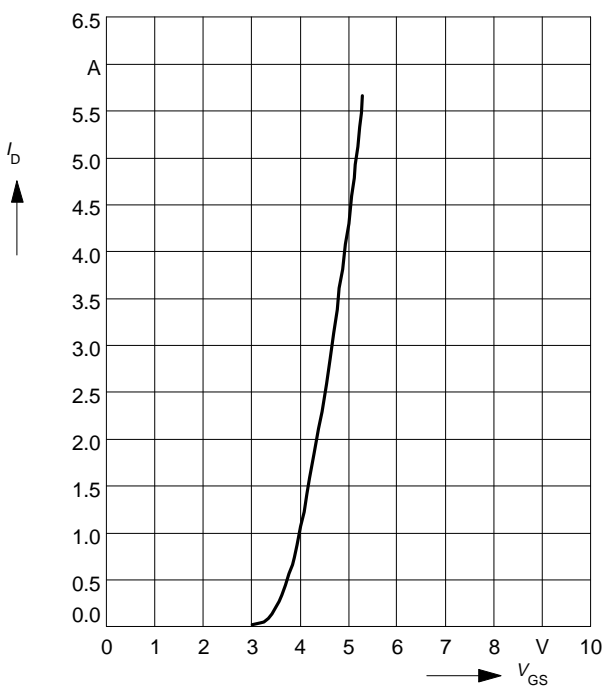

Typ. forward transconductance $g_{fs} = f(I_D)$

parameter: $t_p = 80 \mu s,$

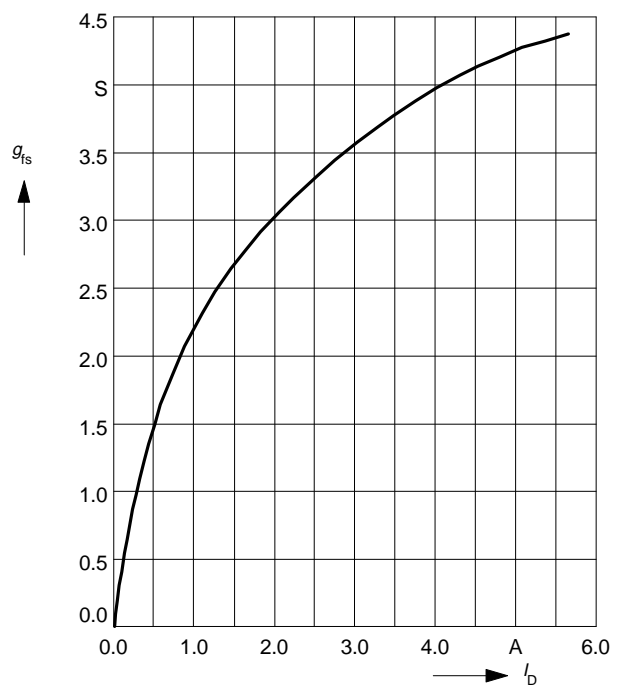

Drain-source on-resistance

$$R_{DS(on)} = f(T_j)$$

parameter: $I_D = 1.7 \text{ A}$, $V_{GS} = 10 \text{ V}$

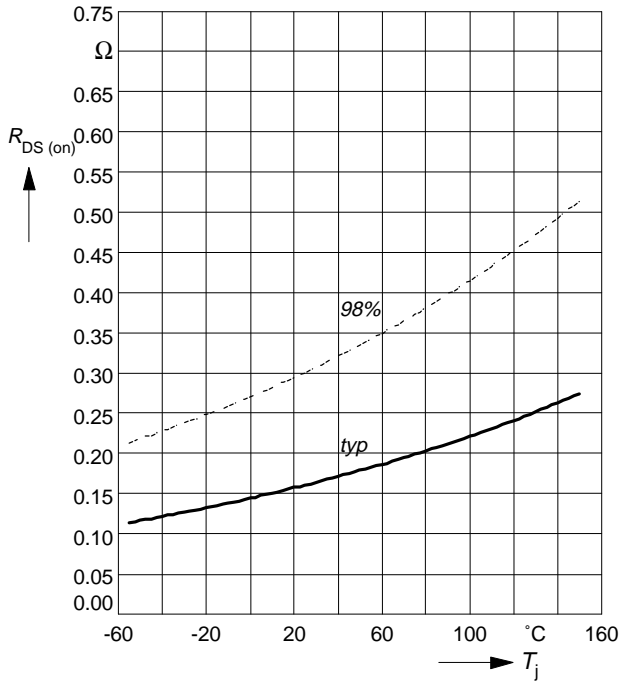

Gate threshold voltage

$$V_{GS(th)} = f(T_j)$$

parameter: $V_{GS} = V_{DS}$, $I_D = 1 \text{ mA}$

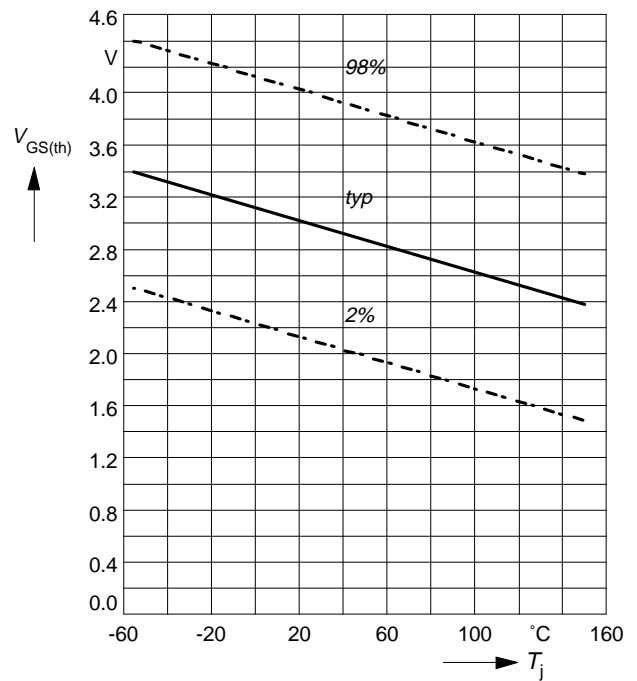

Typ. capacitances

$$C = f(V_{DS})$$

parameter: $V_{GS} = 0 \text{ V}$, $f = 1 \text{ MHz}$

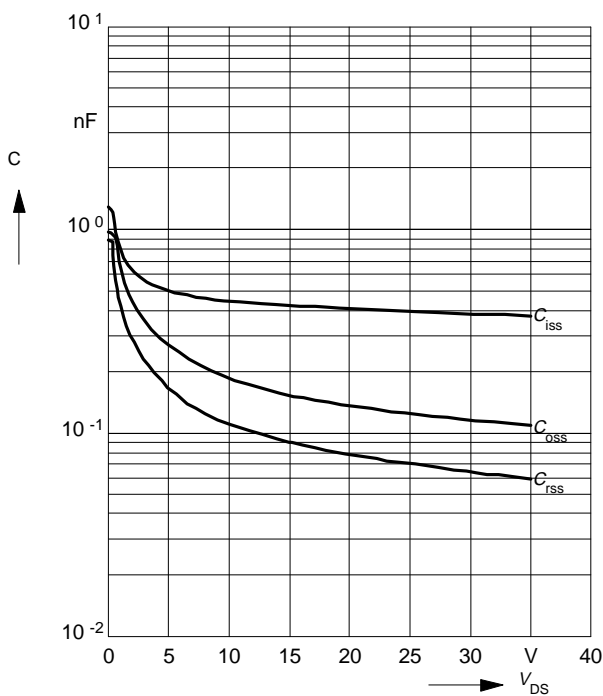

Forward characteristics of reverse diode

$$I_F = f(V_{SD})$$

parameter: $T_j, t_p = 80 \mu\text{s}$

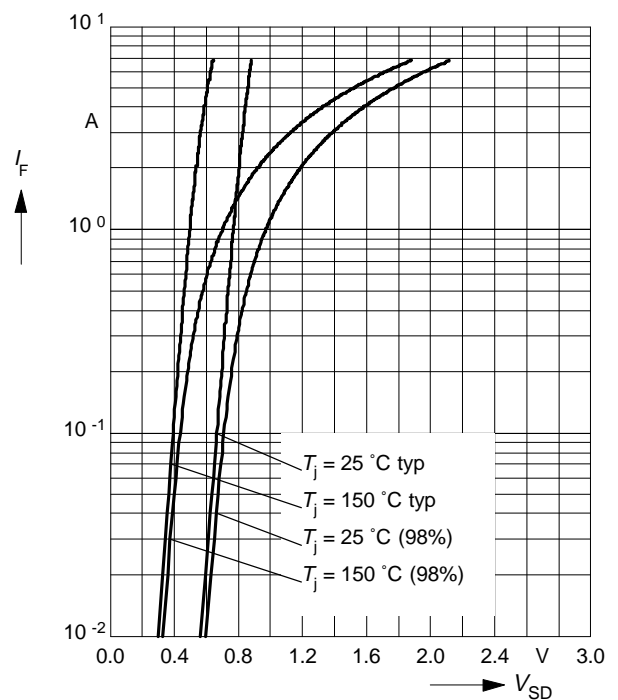

Avalanche energy $E_{AS} = f(T_j)$
 parameter: $I_D = 1.7 \text{ A}$, $V_{DD} = 25 \text{ V}$
 $R_{GS} = 25 \text{ } \Omega$, $L = 23.3 \text{ mH}$

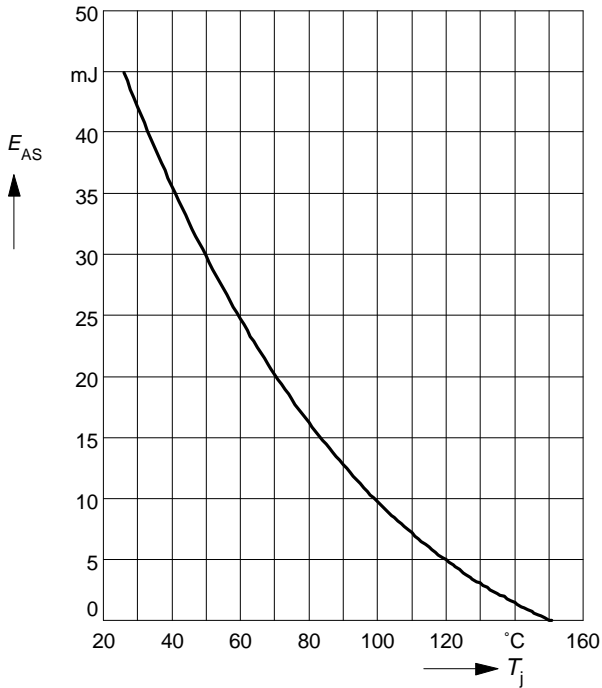

Drain-source breakdown voltage

$V_{(BR)DSS} = f(T_j)$

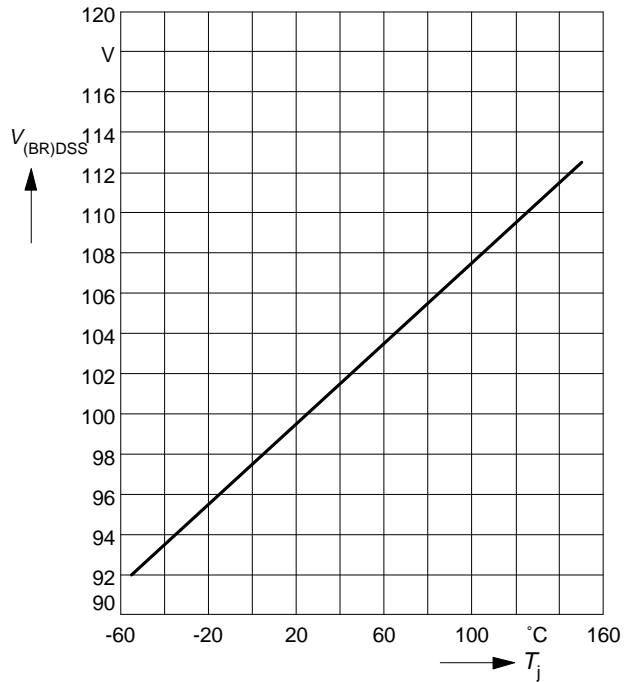

Safe operating area $I_D = f(V_{DS})$

parameter : $D = 0.01$, $T_C = 25^\circ\text{C}$

